



TPL 121250A ▶ 12V 125Ah

TPL 121250A is a front terminal battery up to 12 years expected life under normal float charge As with all CSB batteries, all are rechargeable, highly efficient, leak proof and maintenance free.



Specification

Cells Per Unit	6
Voltage Per Unit	12
Capacity	125Ah @ 8hr-rate to 1.75V per cell @25 °C (77°F)
Weight	Approx. 44.7kg(98.55 lbs)
Maximum Discharge Current	800A(5sec)
Internal Resistance	Approx. 6.5 m Ω
Operating Temperature Range	Discharge: -15°C~50°C (5°F~122°F) Charge: -15°C~40°C (5°F~104°F) Storage: -15°C~40°C (5°F~104°F)
Nominal Operating Temperature Range	25°C±3°C(77°F±5°F)
Float Charging Voltage	2.275 ± 0.025V / Cell at 25 °C (77°F) Temp. Coefficient ±3.3mV/°C (± 1.8mV/°F)
Recommended Maximum Charging Current Limit	37.5A
Equalization / Cycle Use Charging Voltage	2.45V Temps coefficient ±0.05mV/°C (± 1.8mV/°F)
Terminal	I2-Thread lead alloy recessed terminal to accept M6 bolt
Terminal Hardware Initial Torque	120-in-lbs.(13.58 N-m)
Container Material	ABS(UL94-V0) & (UL94-HB) / L.O.I higher than 28



CSB-manufactured VRLA batteries are UL-recognized components under UL924 and UL1989.

CSB is also certified by ISO 9001 and ISO 14001.

Dimensions :

Unit: mm (inch)

Overall Height (H)	Length (L)	Width (W)
323.0±2.5 (12.72±0.10)	547.0±2.5(21.54±0.10)	125.6±1.5 (4.94±0.06)

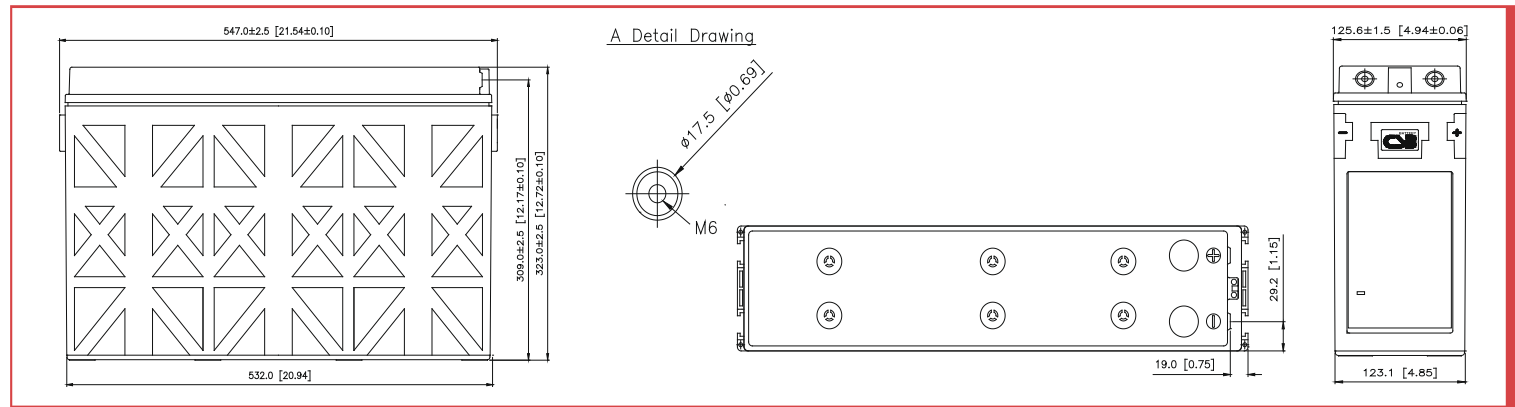

Constant Current Discharge Characteristics Unit:A (25°C ,77°F)

F.V/Time	15MIN	30MIN	60MIN	90MIN	2HR	3HR	4HR	5HR	6HR	7HR	8HR	10HR	20HR
1.67V	232	147	86.3	63.0	50.2	37.0	29.8	24.7	21.1	18.4	16.3	13.3	6.95
1.70V	220	142	84.4	61.8	49.1	36.6	29.4	24.4	20.8	18.1	15.9	13.1	6.88
1.75V	199	132	81.2	59.3	47.2	35.2	28.5	23.4	20.0	17.5	15.6	12.8	6.72
1.80V	176	121	76.7	56.4	45.1	33.8	27.2	22.7	19.5	17.0	15.1	12.5	6.56
1.83V	162	115	73.1	54.5	43.8	32.7	26.4	22.0	19.0	16.5	14.6	12.0	6.41
1.85V	153	110	70.4	52.7	42.8	31.9	25.5	21.5	18.5	16.2	14.4	11.9	6.25
1.90V	131	98.2	64.3	49.1	40.1	29.5	23.4	19.5	16.6	14.7	13.1	10.9	5.78

Constant Power Discharge Characteristics Unit:W (25°C ,77°F)

F.V/Time	15MIN	30MIN	60MIN	90MIN	2HR	3HR	4HR	5HR	6HR	7HR	8HR	10HR	20HR
1.67V	2461	1590	946	695	557	414	335	279	238	208	184	150	78.9
1.70V	2344	1542	936	693	556	413	333	277	237	207	182	149	78.7
1.75V	2138	1456	910	681	555	407	328	270	231	202	180	148	77.9
1.80V	1927	1364	876	665	549	400	317	265	228	198	176	145	77.0
1.83V	1797	1304	844	649	538	389	310	259	224	194	172	142	75.8
1.85V	1705	1255	822	633	529	382	306	254	219	192	170	141	74.3
1.90V	1510	1142	757	581	477	353	281	234	200	176	158	131	69.6

Ratings presented herein are subject to revision without notice. Please refer to www.csb-battery.com to confirm the latest version.

Trickle (or Float) Service Life

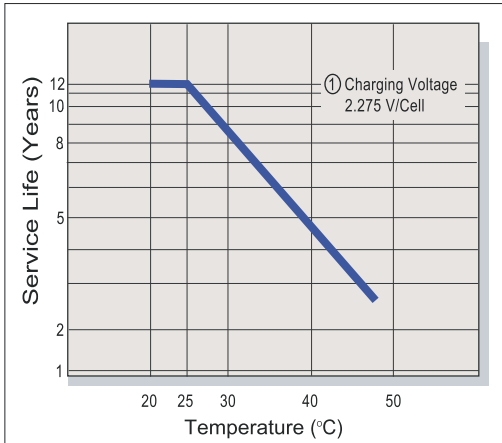

Capacity Retention Characteristic

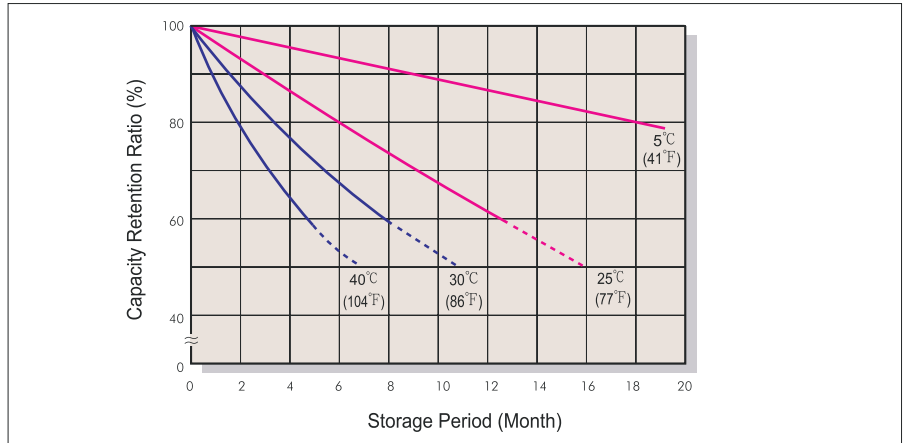

Battery Voltage and Charge Time for Standby Use

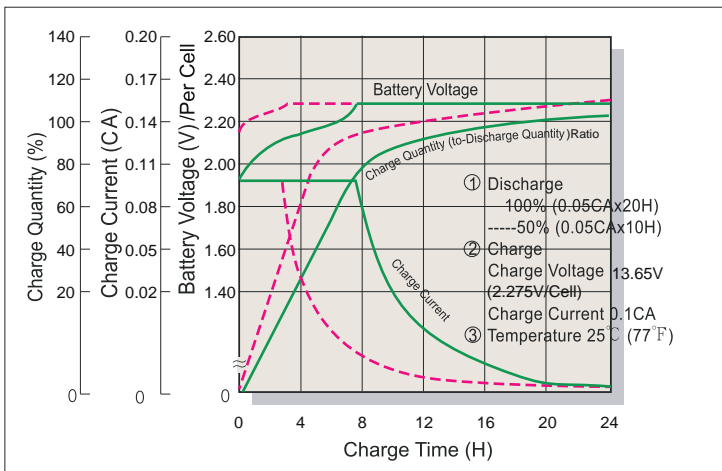

Cycle Service Life

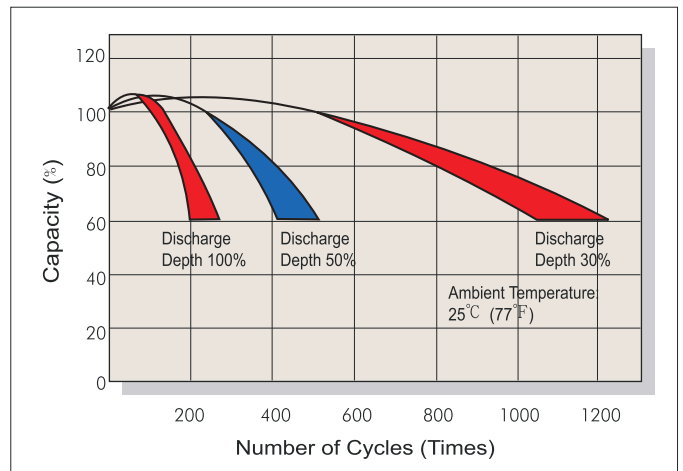

Battery Voltage and Charge Time for Cycle Use

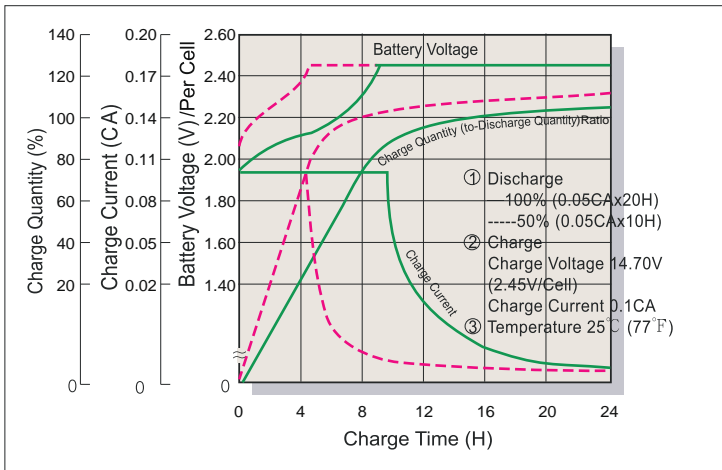

Terminal Voltage (V) and Discharge Time

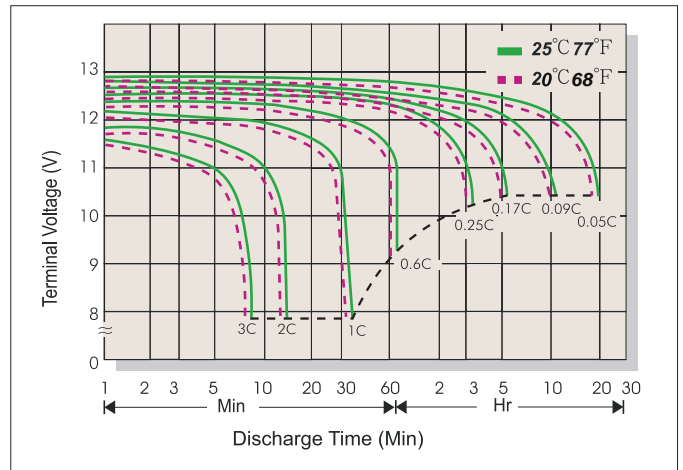

Charging Procedures

Application	Charge Voltage(V/Cell)			Max.Charge Current
	Temperature	Set Point	Allowable Range	
Cycle Use	25°C(77°F)	2.45	2.40~2.50	0.3C
Standby	25°C(77°F)	2.275	2.25~2.30	

Discharge Current VS. Discharge Voltage

Final Discharge Voltage V/Cell	1.75	1.70	1.60	1.30
Discharge Current(A)	0.2C>(A)	0.2C<(A)<0.5C	0.5C<(A)<1.0C	(A)>1.0C

Sales Office URL: WWW.CSB-BATTERY.COM

GLOBAL HQ
CSB BATTERY CO., LTD. (TAIWAN)
 Tel : +886-2-2880-5600
 Fax : +886-2-2888-3300
 mail : service@csb-battery.com.tw

BEIJING OFFICE. (CHINA)
CSB BATTERY TECHNOLOGIES (BEIJING) CO., LTD.
 Tel : +86-10-5820-5336/5338
 Fax : +86-10-58203053
 mail : chinasl@csb-battery.com

AMERICA HQ
CSB BATTERY TECHNOLOGIES INC. (U.S.A)
 Tel : +1-817-244-7777/1-(800)3-CSB-USA(272872)
 Fax : +1-817-244-4445
 mail : csb@csb-battery.com

SHANGHAI OFFICE. (CHINA)
CSB BATTERY LOGISTIC (SHANGHAI) CO., LTD.
 Tel : +86-21-5046-1622/5046-0833
 Fax : +86-21-5064-1046
 mail : chinasl@csb-battery.com

EUROPE HQ
CSB Battery Europe BV.
 Tel : +31(0)-180-418-140
 Fax : +31(0)-180-418-327
 mail : eurosales@csb-battery.eu

SHENZHEN OFFICE. (CHINA)
CSB BATTERY LOGISTIC (SHANGHAI) CO., LTD.
 Tel : +86-755-8831-6488/6396/6356
 Fax : +86-755-8831-6548
 mail : she@csb-battery.com.cn